

















OPTIONS	Reference
LOCKING PIN FOR 2 PADLOCKS Ø 4 TO 8 mm (PADLOCK NOT SUPPLIED)	
	Socket-outlet ref. +843
SAFETY HASP FOR UP TO 6 PADLOCKS	
	399A541
LARGER RELEASE BUTTON	
	Ref. socket +453
INLET CAP IP66/IP67	
	251A426
IN-LINE CONNECTIONS (A PAIR OF FINGER DRAW PLATES TO AID CLOSING)	
	611A346
SELF CLOSING/SELF RETURNING LID	
	Socket-outlet ref.+R
COMPATIBILITY WITH DSN SOCKET-OUTLET (INDUSTRIAL RANGE)	
	Contact us.
SELF-EJECTION	
	See page 192

WALL BOX	Incline angle	Input/ Cable outer Ø	Reference
WALL BOX POLY WITH EX POLY CABLE GLAND			
	30°	5-10 mm	251AB5316P
	30°	10-14 mm	251AB53
	30°	12-18 mm	251AB5325P
WALL BOX POLY WITHOUT CABLE GLAND			
	30°	M20	251AB53417
	30°	M25	251AB53418
WALL BOX POLY WITH EX POLY CABLE GLAND			
	70°	10-14 mm	251AB8820P
	70°	12-18 mm	251AB8825P
	70°	16-25 mm	251AB8832P
WALL BOX POLY WITH METAL CABLE GLAND WITH EARTH CONTINUITY			
	70°	8-10 mm	251AB8820M
	70°	12-14 mm	251AB8825M
	70°	18-24 mm	251AB8832M
WALL BOX POLY WITH TERMINAL BLOCKS (IECEx LCIE 16.0042X/LCIE 16 ATEX 3054X)			
	70°	10-14 mm	251A08820P ⁽¹⁾
	70°	12-18 mm	251A08825P ⁽¹⁾

1. Delivered with two predrilled entries fitted with 1 cable gland and 1 stopping plugs, 8+2 terminals up to 4 mm² with 2.5 mm² wires. Wiring : 1-4 mm². For other configurations, contact us.

HANDLES	Cable outer Ø	Reference
POLY HANDLE WITH GLAND EX POLY		
	10-14 mm	251A753
	12-18 mm	251A25325P
	16-25 mm	251A25332P
POLY HANDLE WITH EX POLY GLAND FOR SELF-EJECTION OPTION		
	10-14 mm	251A463
	12-18 mm	251A44325P
STRAIGHT POLY HANDLE WITH METAL CABLE GLAND WITH EARTH CONTINUITY		
	8-10 mm	251A25320M
	12-14 mm	251A25325M
	18-24 mm	251A25332M

SLEEVE	Incline angle	Reference
INCLINED POLY SLEEVE		
	30°	251A057
	70°	251A757

20 A

440 V
U MAXI

ZONE 2-22 PLUGS & SOCKETS DXN1



MARECHAL ELECTRIC FRANCE

II 3 GD Ex ec IIC T* Gc
 Ex tc IIIC T* Dc
 * -40 °C ≤ Ta ≤ +60 °C T5 T95 °C
 -40 °C ≤ Ta ≤ +40 °C T6 T75 °C
 TF: MAR X 23.0002



IP66
IP67



1-2,5 mm² (1)
1,5-4 mm² (2)



GRP



IK09



-40 °C
+60 °C



ATEX



2, 22



2 PIL⁽³⁾

(1) Flexible wiring (min.-max.).
(2) Stranded wiring (min.-max.).
(3) Câblage souple 0,8 mm².



Other configurations
on request

TEMPERATURE RATING

Gas temperature classes	T6 for an ambient T° between -40 °C and +40 °C T5 for an ambient T° between -40 °C and +60 °C
Dust surface temperature classes	Surface T° ≤ 75 °C for an ambient T° between -40 °C and +40 °C Surface T° ≤ 95 °C for an ambient T° between -40 °C and +60 °C

STANDARDS

International and European IEC/EN standards	60079-0, 60079-7, 60079-31
Protection mode	ec, tc

SOCKET-OUTLET

female
DXN1



INLET* male
DXN1











Voltage	Contact Config	Socket-Outlet Part No.	Inlet Part No.
20-24 V AC	2P	251408AMZ2	251808AMZ2
220-250 V AC	1P+N+E	2514015MZ2	2518015MZ2
380-440 V AC	3P+E	2514013MZ2	2518013MZ2
380-440 V AC	3P+N+E	2514017MZ2	2518017MZ2



► Other currents, voltages, frequencies and contact configurations are available (see page 14).
* inlet cap included.



Each socket outlet
or inlet must be
associated with a box,
a sleeve or a handle.

OPTIONS	Reference
SAFETY HASP FOR UP TO 6 PADLOCKS	
	399A541
LARGER RELEASE BUTTON	
	Ref. socket +453
INLET CAP IP66/IP67	
	251A426
IN-LINE CONNECTIONS (A PAIR OF FINGER DRAW PLATES TO AID CLOSING)	
	611A346
SELF CLOSING/SELF RETURNING LID	
	Socket-outlet ref.+R
COMPATIBILITY WITH DSN SOCKET-OUTLET (INDUSTRIAL RANGE)	
	Contact us.

WALL BOX	Incline angle	Input/ Cable outer Ø	Reference
WALL BOX POLY WITH EX POLY CABLE GLAND			
	30°	5-10 mm	251AB5316P
	30°	10-14 mm	251AB53
	30°	12-18 mm	251AB5325P
WALL BOX POLY WITHOUT CABLE GLAND			
	30°	M20	251AB53417
	30°	M25	251AB53418
WALL BOX POLY WITH EX POLY CABLE GLAND			
	70°	10-14 mm	251AB8820P
	70°	12-18 mm	251AB8825P
	70°	16-25 mm	251AB8832P
120 X 120 mm			
WALL BOX POLY WITH METAL CABLE GLAND WITH EARTH CONTINUITY			
	70°	8-10 mm	251AB8820M
	70°	12-14 mm	251AB8825M
	70°	18-24 mm	251AB8832M
120 X 120 mm			
WALL BOX POLY WITH TERMINAL BLOCKS (TF: MAR X 14.0001)			
	70°	10-14 mm	Contact us
	70°	12-18 mm	Contact us
120 X 120 mm			

HANDLES	Cable outer Ø	Reference
POLY HANDLE WITH GLAND EX POLY		
	10-14 mm	251A753
	12-18 mm	251A25325P
	16-25 mm	251A25332P
STRAIGHT POLY HANDLE WITH METAL CABLE GLAND WITH EARTH CONTINUITY		
	8-10 mm	251A25320M
	12-14 mm	251A25325M
	18-24 mm	251A25332M

SLEEVE	Incline angle	Reference
INCLINED POLY SLEEVE		
	30°	251A057
	70°	251A757

DRAWINGS AND DIMENSIONS

PLUG ON SOCKET-OUTLET

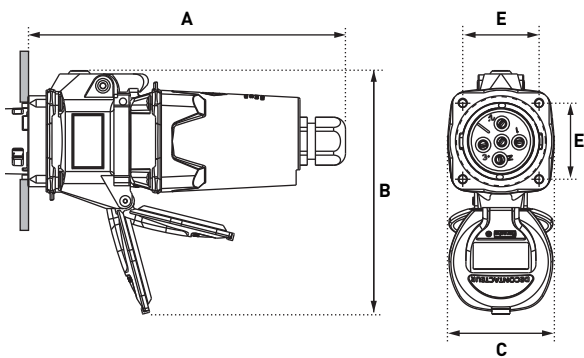

A	B	C	E
165	134	58	42

COUPLER

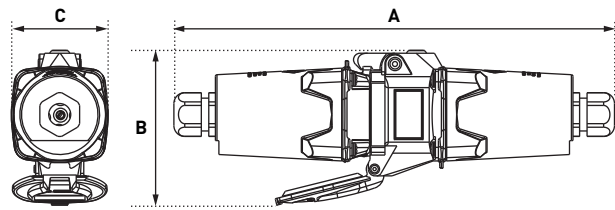

A	B	C
266	89	58

PLUG ON 30° WALL MOUNTED SOCKET OUTLET

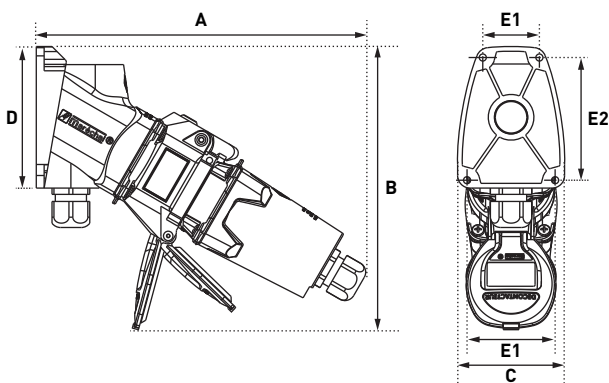

A	B	C	D	E1	E2
209	180	68	90	36/56	79

PLUG ON 70° WALL-MOUNTED SOCKET-OUTLET

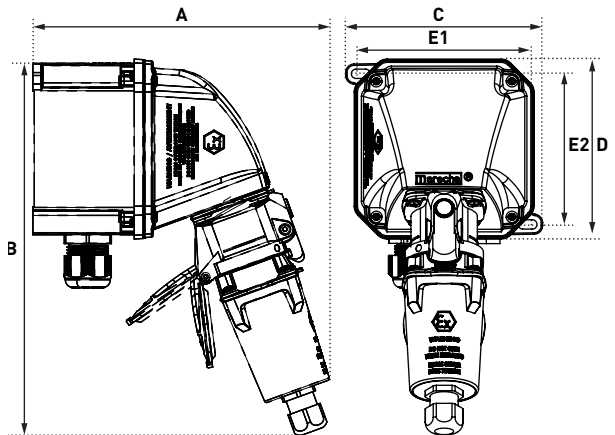

A	B	C	D	E1	E2
208	264	138	126	117	105.5

PLUG ON 30° INCLINED SOCKET-OUTLET

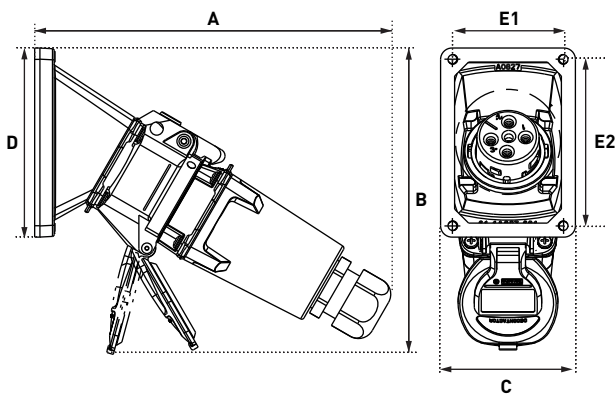

A	B	C	D	E1	E2
203	175	77	108	64	96

PLUG ON 70° INCLINED SOCKET-OUTLET

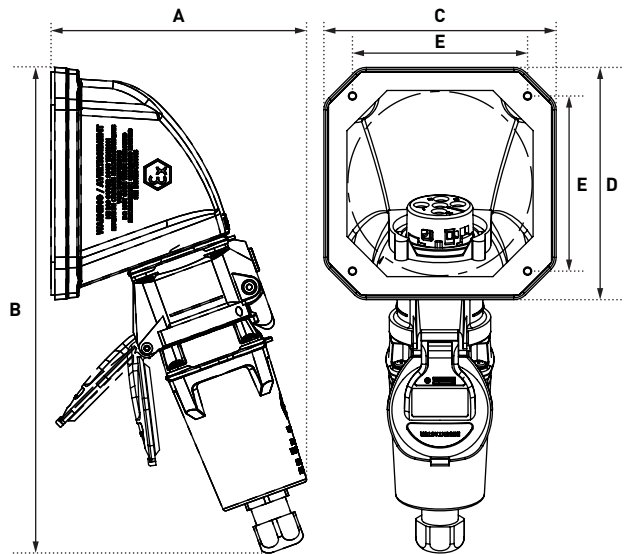

A	B	C	D	E
139	264	126	126	95

